

TRUE  FLAME

OUTDOOR KITCHEN CATALOG



YOUR
BACKYARD
CONSCIOUSLY
CRAFTED.



TF GRILLS

TF 40

TF 32

TF 25

The TrueFlame grill redefines value with premium craftsmanship. Available in 40", 32", & 25" models, each is packed with all the features you could hope for in a grill. Interior and exterior lighting, square stainless steel cooking grates, heat separators for optimal control make gourmet grilling easy. With the Gold Standard Lifetime Warranty, this is a commercial-grade quality grill you can trust. Beauty & durability come together to create this truly high performance grill.

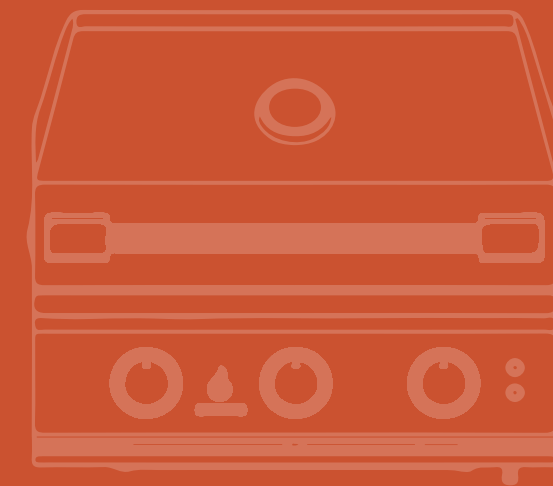
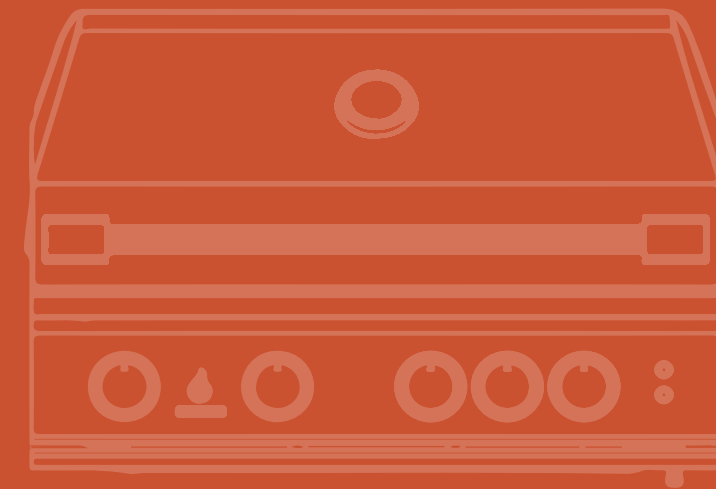



TRUEFLAME GRILL SERIES

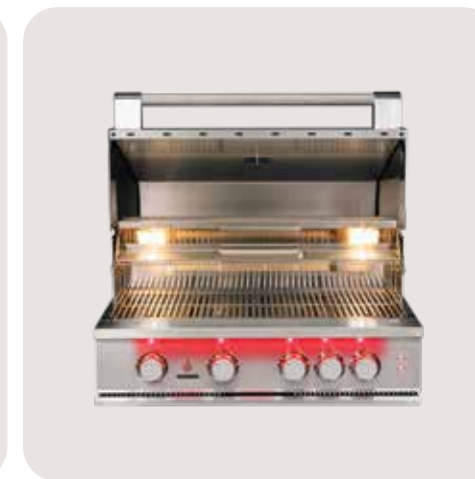
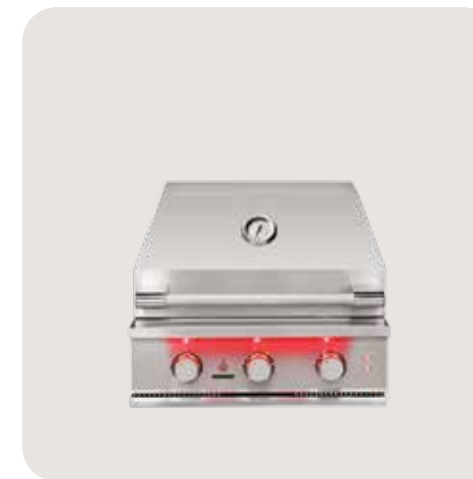

TrueFlame Grill - 25", 32", 40"

TF25-NG/LP, TF32-NG/LP, TF40-NG/LP

- . Exterior Lighting Behind Each Knob Indicating On/Off Burner State
- . Full Length Exterior LED Bar Above Knobs
- . Halogen Interior Lighting
- . Heat Zone Separators
- . #304 Stainless Steel Flame Tamers / Burner Covers
- . Square Stainless Steel Cooking Grates
- . Constructed with #304 Stainless Steel
- . 14,000 BTU Burners #304 Cast Stainless Steel Burners
- . Flame Thrower Ignition

- . 10,000 BTU Infrared Back Burner (32" & 40" Only)
- . Balanced, Multi-Position Hood Hinge
- . Warming Rack with Inset, Removable Cooking Tray
- . ETL Certified

OPTIONAL ACCESSORIES:

- . Rotisserie Kit Available (25", 32", 40")
- . Deluxe Vinyl Grill Cover Available
- . Drop-In Sear Burner (TF-IRB) Available



#304 Stainless Steel Construction

TrueFlame grills are constructed of the highest quality #304 stainless steel, adding a luxurious sheen and elegant touch to your backyard. This premium material is highly resistant to rust, discoloration, and wear, ensuring that your grill looks great and performs reliably for years to come.



Interior & Exterior Lighting

Two interior Halogen Lights help illuminate the expansive grilling surface, while a full-length LED strip gives maximum front panel visibility. The knobs feature a backlit ON/OFF indication light, so you can easily and safely see which burners are ignited.



Square Cooking Grates

Heavy-duty Square Cooking Grates increase the contact surface with your food, offering beautiful grill lines and bolstering the flavor profile. These cooking grids are stainless steel, making them long-lasting and easy to clean.



Multi-Position Hood Hinge

The balanced, Multi-Position Hood Hinge allows you to open your hood to any degree, gaining access to your food without losing too much heat—plus, the knurled finish of the stainless steel hood handle provides extra grip when lifting the hood.



14,000 BTU Cast Stainless Burners

A trusted Flame-Thrower Ignition mechanism ignites 14,000 BTU Cast Stainless Burners, supplying incredible heat for searing and grilling. These burners are cast from #304 stainless steel, ensuring longevity, durability, and performance.



IR Back Burner & Rotisserie Kit

The 32" and 40" models feature a 10,000 BTU Infrared Back Burner with an optional Rotisserie Kit, allowing you to enjoy perfectly cooked, juicy meats as they slowly turn on the spit, infusing them with delicious flavor and an irresistible aroma. Rotisserie Kit available for 25" Grill.



Warming Rack with Cooking Tray

A full-length, stainless steel warming rack not only adds to the useable cooking surface of your grill, but also features an inset, removable stainless steel tray for cooking vegetables, searing, roasting, and more.



#304 Stainless Steel Flame Tamers

The #304 Stainless Flame Tamers / Burner Covers are designed to provide superior protection and durability to your grill's burners, while also distributing heat and vaporizing drippings. They are easy to remove and install, making it effortless to maintain the quality and cleanliness of your grill.

TFE GRILLS

TFE 32

TFE 25

The TrueFlame TFE grill redefines value with premium craftsmanship. Available in a 32" & 25" models, each is packed with features and built-to-last. 14,000 BTU stainless steel tube burners, #304 stainless steel construction, & a meticulously designed profile ensure this grill not only stands the test of time but supports amazing culinary results. Elevate your outdoor environment with this commercial-grade, quality grill you can trust, all backed by the Gold Standard Lifetime Warranty

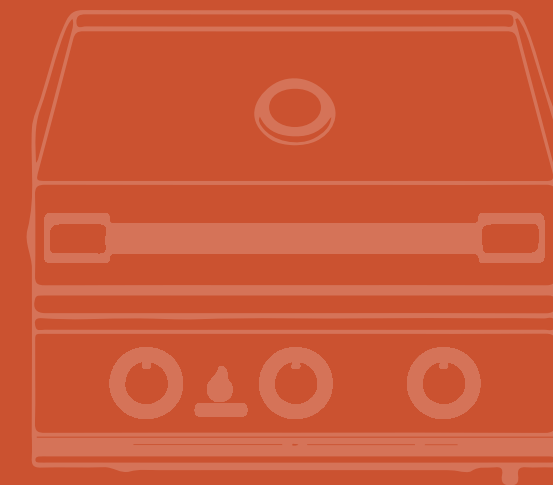
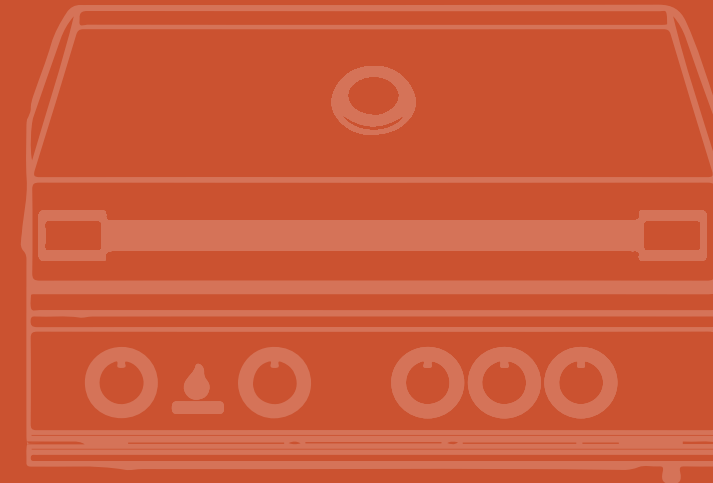



TRUEFLAME TFE GRILL SERIES



TFE Grill - 25" & 32"

TFE25-NG/LP, TFE32-NG/LP

- Heat Zone Separators
- #304 Stainless Steel Flame Tamers / Burner Covers
- 8mm Round Stainless Steel Cooking Grates
- Constructed with #304 Stainless Steel
- 14,000 BTU #304 Stainless Steel Tube Burners
- Knurled Heat-Resistant Handle
- Flame Thrower Ignition
- ETL Certified

OPTIONAL ACCESSORIES:

- Deluxe Vinyl Grill Cover
- Rotisserie Kit Available
- Drop-In Sear Burner (TF-IRB)
- Gas Timers





FREESTANDING CARTS

TrueFlame's premium grill carts offer an alternative solution to outdoor dining. Durable and sleek, these stainless steel carts feature propane tank storage, paper towel holder, and collapsible shelving. These cart models fit both the TF grills and TFE grills.



TF GRILL SHOWN



TFE GRILL SHOWN

TrueFlame Deluxe Grill Cart

CART-TF-25DC / CART-TF-32DC / CART-TF-40DC

- Commercial Grade Stainless Steel
- Magnetic Access Doors
- Front Locking Caster Wheels
- Interior Paper Towel Holder
- 2 Foldable Side Shelves
- Propane Tank Storage
- Side, Rear, and Bottom Ventilation

TF GRIDDLE

TFG30

Explore new flavors with the premium 30" Gas Griddle Grill. This #304 stainless steel, heavy-duty flat top grill is the perfect addition to your outdoor kitchen, diversifying your menu, and adding a host of new flavors. The expansive, 495-square-inch cooking surface is made of half-inch thick steel, powered by two 18,000 BTU U-Tube Burners below. The combined 36,000 BTUs of power guaranty searing heat, perfect for steaks, burgers, carne asada, eggs, pancakes, and more. The full-size, #304 stainless steel cover ensures your griddle plate is protected from the elements and always ready for the next meal. Fire up the Gas Griddle and take your culinary experiences to new heights.



TRUEFLAME GAS GRIDDLE



TrueFlame 30" Gas Griddle

TFG30-NG/LP



TrueFlame 30" Gas Griddle Cart

CART-TF-GRID30



FEATURES

- Exterior Lighting Behind Each Knob Indicating On/Off Burner State
- #304 Stainless Steel Construction
- 1/2" Thick Stainless Steel Cooking Surface
- 495 Sq. Inches of Cooking Surface
- 18,000 BTU #304 Stainless Steel U-Tube Burners
- 36,000 Total BTU Output
- Heat Zone Separator, allowing Dual-Temperature Cooking
- Full Length Exterior LED Bar Above Knobs
- #304 Stainless Steel, Removable Lid
- High-Power, Reliable Flame-Thrower Ignition
- Large Capacity Drip Tray
- Grill Liner Available - GL-TFGRID30
- Weight: 120 LB.
- ETL Certified
- Deluxe Vinyl Grill & Cart Cover Available

TF SIDE BURNERS

TF SB 2

TF PB

The TrueFlame Side & Power Burners combine the benefits of an indoor range with the joy of cooking outdoors. The perfect addition to your outdoor kitchen, these appliances offer convenience and performance to your outdoor oasis. With the matching design and exterior LED lights of the TrueFlame grill line, these burners bring high BTU output to boil, cook, or saute while you grill. Upgrade your outdoor kitchen today, so you're ready for the backyard gathering of a lifetime.





FEATURED:
TRUEFLAME DOUBLE SIDE BURNER

SIDE & POWER BURNER

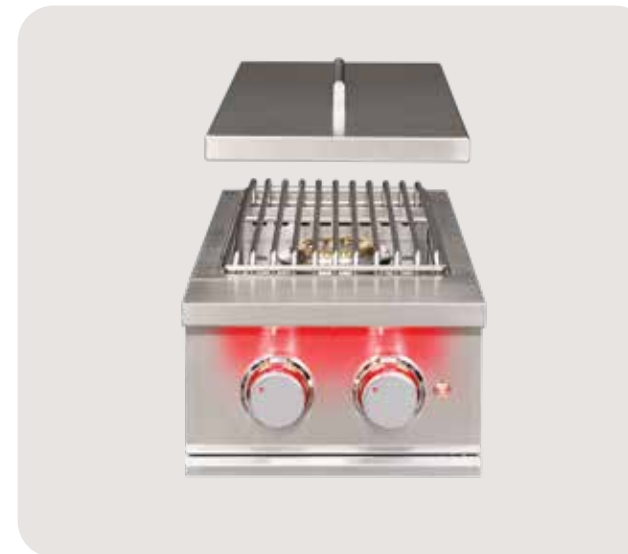

TrueFlame Double Side Burner

TFSB2-NG/LP

- Exterior Lighting Behind Each Knob Indicating On/Off Burner State
- Full Length Exterior LED Bar Above Knobs
- Total BTU's 24,000
- Stainless Steel Construction
- Removable, Stainless Steel Lid
- Brass Plated Burners
- ETL Certified
- Deluxe Vinyl Cover Available



TrueFlame Power Burner

TFPB-NG/LP

- Exterior Lighting Behind Each Knob Indicating On/Off Burner State
- Full Length Exterior LED Bar Above Knobs
- Total BTU's: 60,000
- Stainless Steel Construction
- Removable, Stainless Steel Lid
- Dual, Cast Stainless Ring Burners
- Removable Wok Grate
- ETL Certified
- Deluxe Vinyl Cover Available

Enjoy fresh ingredients and chilled beverages with AMD Direct's extensive line of outdoor refrigeration. With up to 6.6 cubic feet of storage, these appliances will facilitate food preparation and storage needs for your outdoor kitchen. All AMD Direct refrigeration offers durable construction for the outdoors, temperature control, adjustable legs for leveling, and sleek design for function and beauty. Bring the function of your indoor refrigeration outside with matching performance and design.

AMD DIRECT

OUTDOOR REFRIGERATION

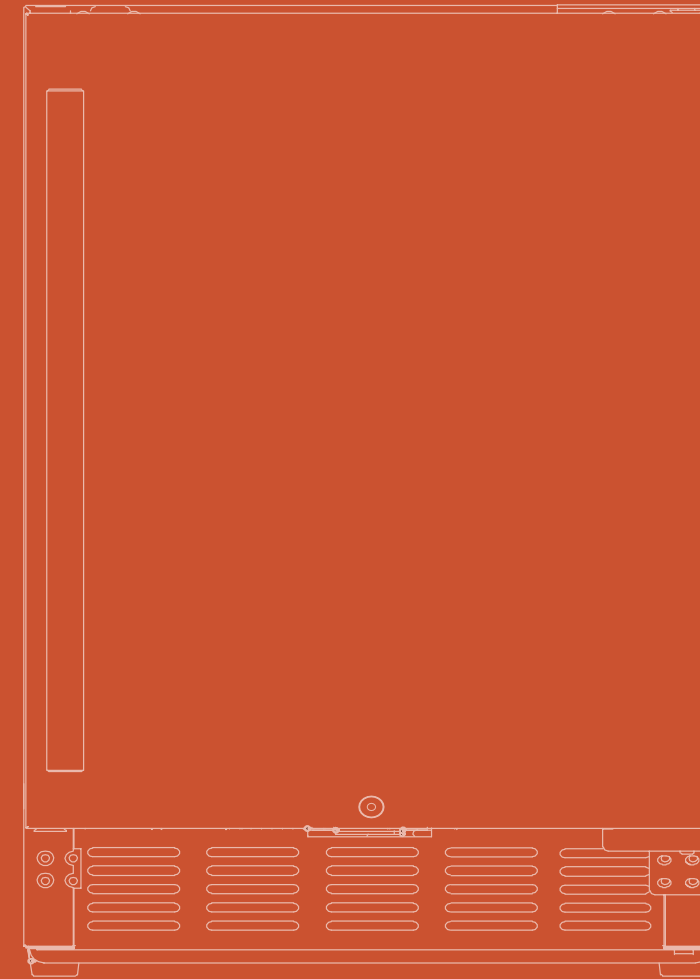

REFRIGERATION

FEATURES:

- #304 Stainless Steel Door Construction
- UL Rated for Outdoor Use
- Locking Doors (excludes 24DR2-A)
- Interior LED Lighting
- Front Venting
- Auto-Defrost
- Electronic Temperature Controller w/ Digital Display
- Built-In Design
- Commercial & Residential Compliant
- Anti-Vibration System
- Certifications: ETL, DOE, CE



FEATURED:
TF-RFR-24S-R (Left)
TF-RFR-24S (Right)

24" 5 cu. Outdoor Rated Double Drawer Refrigerator

NEW PRODUCT

TF-RFR-24DR2-A

- Storage Capacity: 5 ft³
- 114 Can Capacity
- Stainless Steel Interior Drawers
- Interior LED Light
- 32°F - 72°F Temperature Range
- Black Interior & Exterior Cabinet
- Self-Closing #304 Stainless Steel Door
- #304 Stainless Steel Body & Handle



24" 5.3 cu. Deluxe Outdoor Rated Refrigerator

TF-RFR-24D / TF-RFR-24D-R

- Storage Capacity: 5.3 ft³
- 165 Can Capacity
- 32°F - 50°F Temperature Range
- Self-Closing #304 Stainless Steel Door
- #304 Stainless Steel Body & Handle
- Left & Right Doors Available

15" 3.2 cu. Outdoor Rated Refrigerator

TF-RFR-15S

- Storage Capacity: 3.2 ft³
- 32°F - 50°F Temperature Range
- Self-Closing #304 Stainless Steel Door
- #304 Stainless Steel Body & Handle

15" 3.2 cu. Outdoor Rated Refrigerator with Glass Door

TF-RFR-15G

- Storage Capacity: 3.2 ft³
- 32°F - 50°F Temperature Range
- Black Interior
- Triple-Glazed Tinted Glass Door
- Self-Closing #304 Stainless Steel Door
- #304 Stainless Steel Body & Handle





24" 5 cu. Outdoor Rated Refrigerator

NEW PRODUCT

TF-RFR-24S-A

- Storage Capacity: 5 ft³
- 161 Can Capacity
- Glass Shelves (x3)
- Black Exterior & Interior Cabinet
- 32°F - 72°F Temperature Range
- Self-Closing #304 Stainless Steel Door
- #304 Stainless Steel Body & Handle
- Reversible door (right or left opening)



24" 5 cu. Outdoor Rated Refrigerator with Glass Door

NEW PRODUCT

TF-RFR-24G

- Storage Capacity: 5 ft³
- 161 Can Capacity
- 32°F - 72°F Temperature Range
- Glass Shelves (x3)
- Triple-Glazed Self-Closing Tinted Glass Door w/ #304 Stainless Steel Frame & Handle

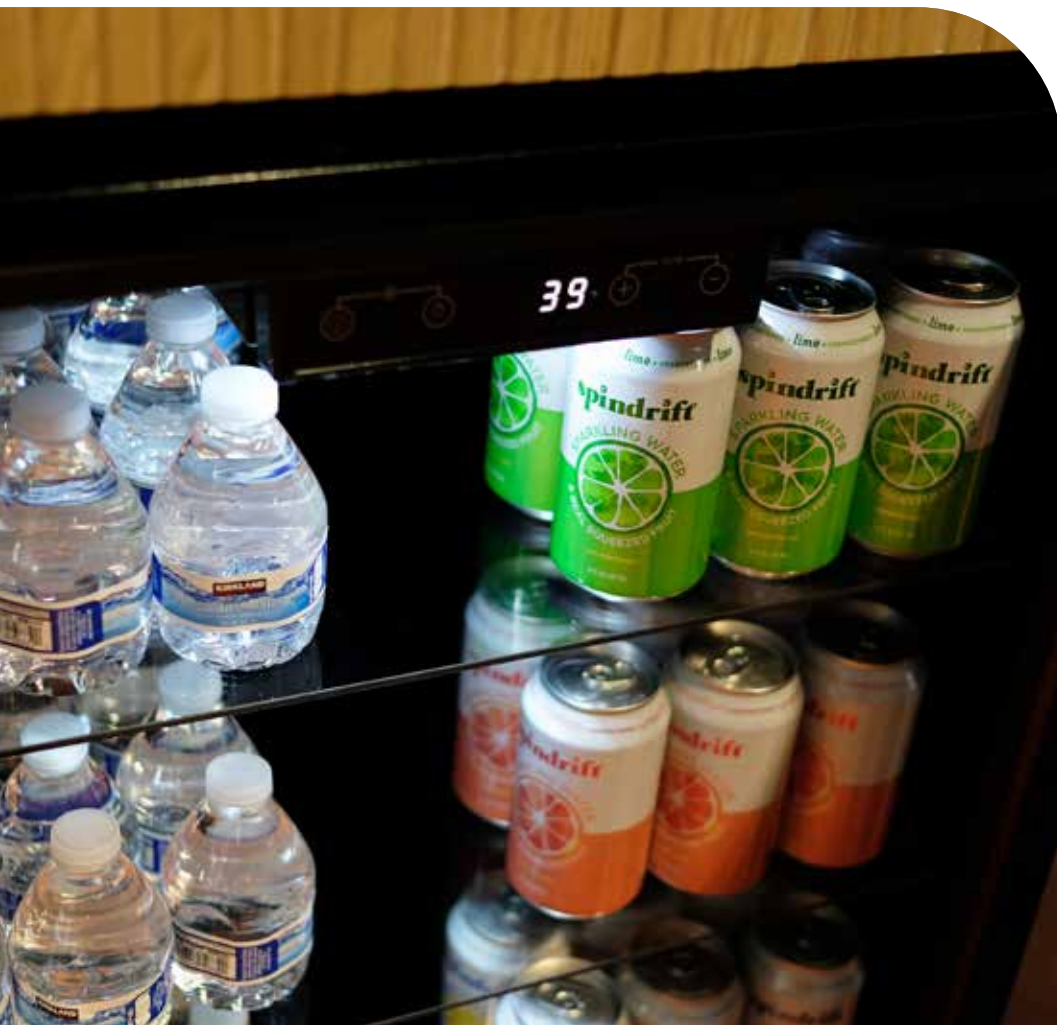

FEATURED:
24" OUTDOOR REFRIGERATOR

OUTDOOR RATED

22" REFRIGERATION SERIES

FEATURES:

- Storage Capacity: 4.1 ft³
- Black Exterior & Interior Cabinet
- Black Wire Shelves (x4)
- Interior LED Light
- Full Range Mechanical Temperature Controls with 7 Settings
- Temperature Range: 0°C - 10°C / 32°F - 50°F
- 156 Can Capacity
- Energy Efficient Rating: DOE Household
- Certifications: ETL, DOE, CE
- Trim Kit Available: TF-RTK-22

The 22" Compact Refrigerator Series offers 4.1 cubic feet of storage, #304 Stainless Steel doors, and automatic interior lighting. Build them into an island or use them inside—these refrigerators will add a whole new level of convenience to your setup.



22" 4.1 cu. Compact Refrigerator

NEW PRODUCT

TF-RFR-22S

- Storage Capacity: 4.1 ft³
- #304 Stainless Steel Reversible Door with Lock
- Upgraded Deluxe #304 Stainless Steel Door Sleeve w/ Handle Available

22" 4.1 cu. Deluxe Compact Refrigerator

NEW PRODUCT

TF-RFR-22D / TF-RFR-22D-R

- Storage Capacity: 4.1 ft³
- Upgraded Deluxe #304 Stainless Steel Door w/ Lock & Handle
- Right to Left Opening Model Available (RFR-22D-R)

WINE COOLERS

FEATURES

- Double-Glazed, Self-Closing, Tinted Glass Door w/ #304 Stainless Steel Frame & Handle
- UL Rated for Outdoor Use
- Locking Doors
- Interior LED Lighting
- Front Venting
- Auto-Defrost
- Electronic Temperature Controller w/ Digital Display
- Built-In Design
- Commercial & Residential Compliant
- Anti-Vibration System
- Certifications: ETL, DOE, CE

15" 3.2 cu. Outdoor Rated Dual Zone Wine Cooler

TF-RFR-15WD

- Storage Capacity: 3.2 ft³
- 20 Bottle Capacity
- Upper Temperature Range: 41°F-50°F
- Lower Temperature Range: 50°F-64°F

24" 4.5 cu. Deluxe Outdoor Rated Dual Zone Wine Cooler

TF-RFR-24WD

- Storage Capacity: 4.5 ft³
- 46 Bottle Capacity
- Upper Temperature Range: 41°F-50°F
- Lower Temperature Range: 50°F-64°F



24" 5 cu. Deluxe Outdoor Rated Wine Cooler

TF-RFR-24W

- Storage Capacity: 5 ft³
- 46 Bottle Capacity
- 41°F-64°F Temperature Range

15" 3.2 cu. Outdoor Rated Single Zone Wine Cooler

TF-RFR-15W

- Storage Capacity: 3.2 ft³
- 28 Bottle Capacity
- 41°F - 64°F Temperature Range

FEATURED:
24" DELUXE DUAL ZONE WINE COOLER

OUTDOOR RATED

KEGERATOR

FEATURES:

- #304 Stainless Steel Door Construction
- UL Rated for Outdoor Use
- Locking Doors
- Interior LED Lighting
- Front Venting
- Auto-Defrost
- Electronic Temperature Controller w/ Digital Display
- Built-In Design
- Commercial & Residential Compliant
- Anti-Vibration System
- Certifications: ETL, DOE, CE



24" 6.6C Deluxe Outdoor Rated Kegerator (No Tap / Single Tap / Double Tap)

TF-RFR-24DK / TF-RFR-24DK1 / TF-RFR-24DK2

- Storage Capacity: 6.6 ft³
- Available in Single or Double Tap Towers
- 32°F - 50°F Temperature Range
- Self-Closing #304 Stainless Steel Door, Body & Handle
- Reversible door (right or left opening)



Single Keg Tap for Kegerator

TF-RFR-TAP-1

- Fits TF-RFR-24DK
- Includes Tap Tray, Single Hose, CO2 Kit (Tank & Regulator)



Double Keg Tap for Kegerator

TF-RFR-TAP-2

- Fits TF-RFR-24DK
- Includes Tap Tray, Two Hoses, CO2 Kit (Tank & Regulator)

OUTDOOR RATED

ICE MAKER



50 LB. Deluxe Outdoor Rated Ice Maker with Gravity Drain

TF-IM-15

- Daily Ice Output: 50 lbs.
- Storage Capacity: 25 lbs.
- Gravity Drain
- Temperature Control Not Necessary
- Self-Closing #304 Stainless Steel Door, Body & Handle



TRUEFLAME

SINKS & BAR PREP

Transform your outdoor living space into a culinary haven with our premium selection of outdoor kitchen sinks and bar preparation stations. Our sinks are the perfect addition to any outdoor kitchen, featuring durable Stainless Steel construction with options for under-mount, top-mount, or built-in installation. The stainless steel Lighted Beverage & Prep Station also makes for an entertainer's dream, featuring covered ice storage, sink, bottle opener, condiment bins, and more!

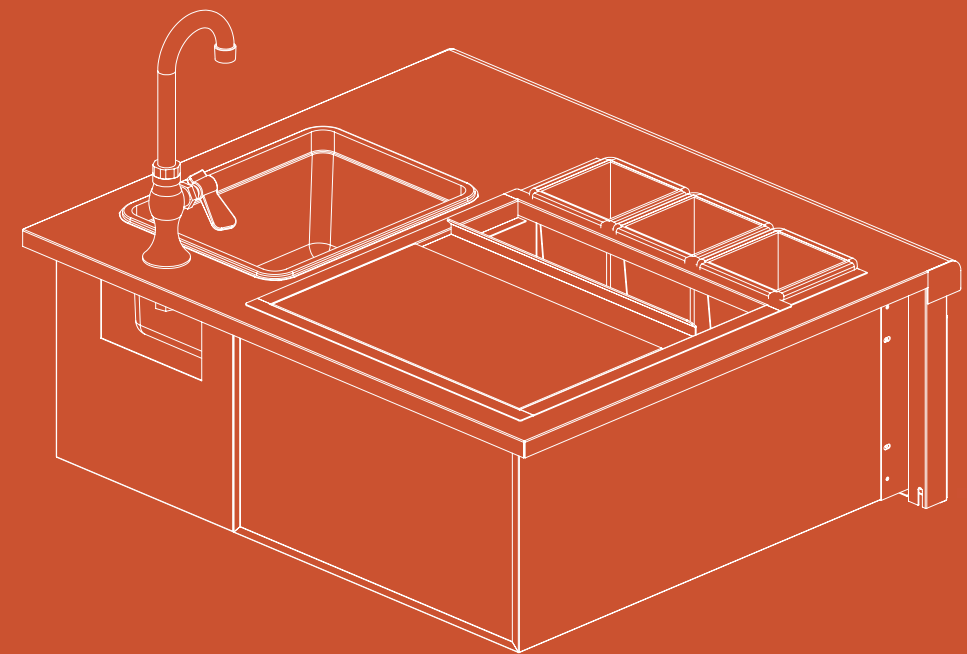
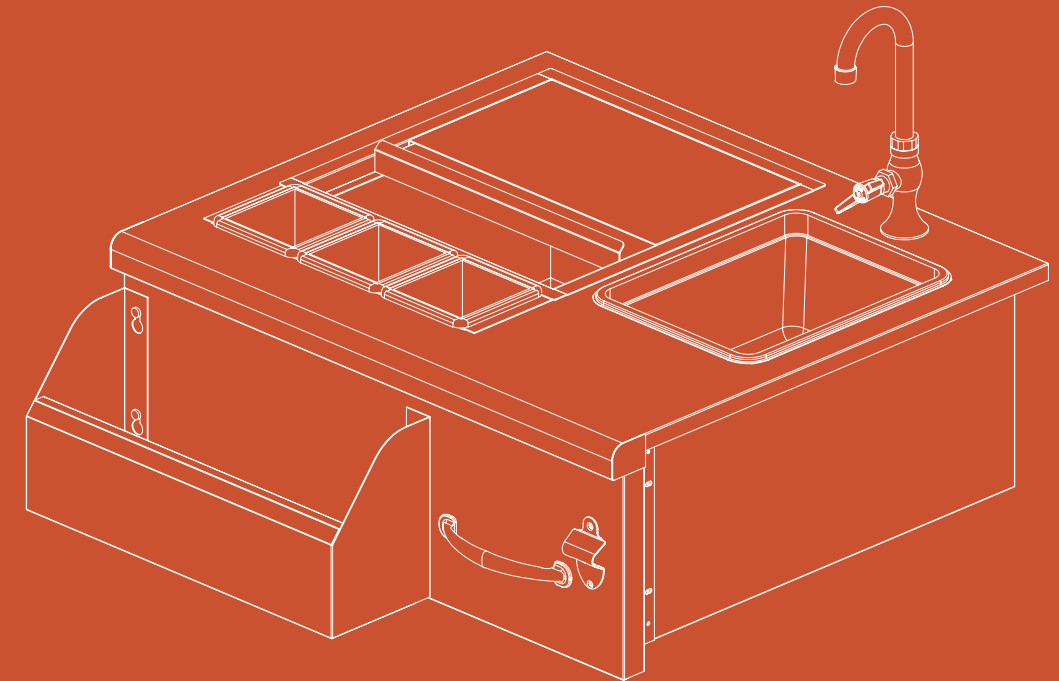

SINKS AND BAR PREP



15" Drop-In Sink & Hot/Cold Faucet
TF-NK-15D



19" Undermount Sink & 360° Hot/Cold Faucet
TF-NK-19U



32" Farmhouse Sink
TF-NK-32FH * FAUCET SOLD SEPARATELY



Lighted Beverage & Prep Station
TF-BC-30L



14" Trash Chute & Cutting Board with Lid
TF-TC-14-A



FEATURED:
28" DROP-IN COOLER

ICE CHESTS

With our grills heating things up, we have just what you need to keep cool. Choose between two sizes to optimize your serving station. With up to 40 lbs. of ice capacity, load them up with your favorite refreshments, snacks, or ingredients to make for a good time.



17" 1.7c Drop-In Cooler (20lb Ice Capacity)
TF-IC-17-A



28" 2.7c Drop-In Cooler (40lb Ice Capacity)
TF-IC-28-A



TRUEFLAME

ACCESSORIES

Make your kitchen the way you want it...TrueFlame offers a variety of miscellaneous conveniences, upgrades, and appliances to customize your outdoor space to your liking. All products feature high-grade stainless steel construction for durability and performance.

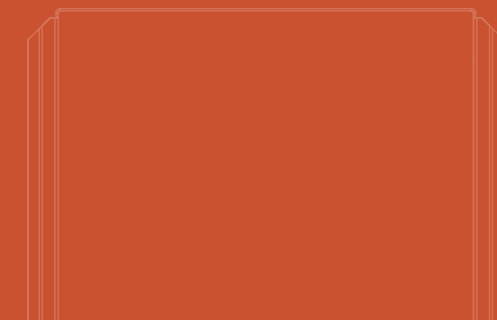

ACCESS DOORS

NEW PRODUCTS

Our access doors give you elegant and convenient access to your island, utilities, and grill. Made with commercial grade stainless steel, hidden hinge design, new handle design, heavy-duty flanges, reversible door mounting, and magnetic latches.

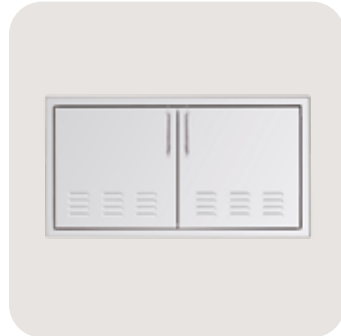

33" Vented Double Access Door

TF-DD-33V-A

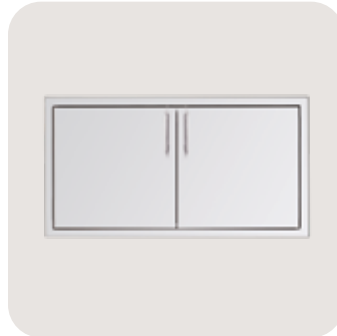

Double Access Door (26" - 45")

TF-DD-26-A / TF-DD-30-A
TF-DD-32-A / TF-DD-33-A
TF-DD-36-A / TF-DD-39-A
TF-DD-40-A / TF-DD-42-A
TF-DD-45-A



Vertical Access Door (16", 17", 18", 20")

TF-DV-16-A / TF-DV-17-A
TF-DV-18-A / TF-DV-20-A

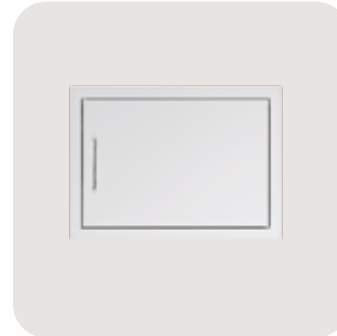

Horizontal Access Door (22", 27")

TF-DH-22-A / TF-DH-27-A

DOOR/DRAWER COMBOS

NEW PRODUCTS

These components are specifically designed with versatility in mind. Whether you need a simple storage setup, LP tank drawer, paper towel holder, or weather-resistant dry storage shelving, these commercial grade stainless steel combos give you the options you need for a perfect outdoor setup. Hidden hinge & handle design.

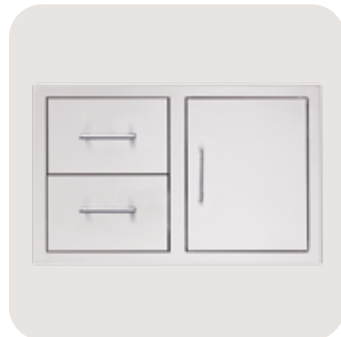

2-Drawer & Access Door Combo (30", 32" 33", 36", 42")

TF-DC2-30-A / TF-DC2-32-A
TF-DC2-33-A / TF-DC2-36-A
TF-DC2-42-A

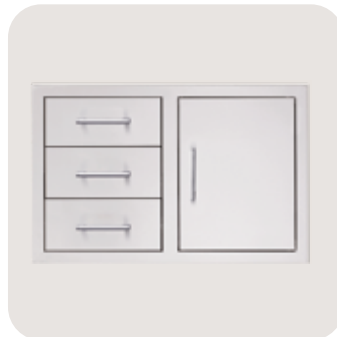

33" 3-Drawer & Access Door Combo

TF-DC3-33-A

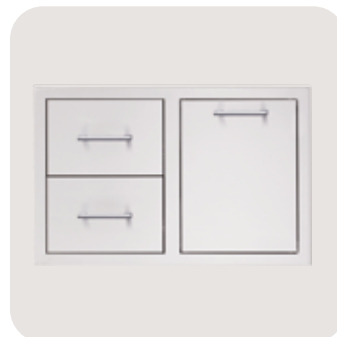

33" 2-Drawer & LP Tank Pullout Drawer Combo

TF-DC2-33LP-A



PROUDLY MADE IN THE USA



FEATURED: 33" 3-DRAWER & ACCESS DOOR COMBO

STORAGE DRAWERS

NEW PRODUCTS

Our line of drawers are feature-packed storage options that ensure you get exactly what you need in your backyard set up. Made with commercial grade stainless steel, these drawers feature heavy-duty flanges, new handle design, and soft closing drawers.

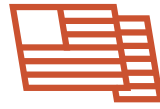

PROUDLY MADE
IN THE USA

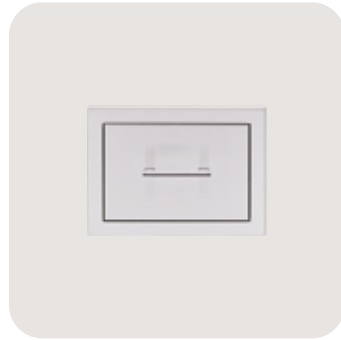

17" Single Drawer

TF-DR1-17-A



17" Double Drawer

TF-DR2-17-A



17" Triple Drawer

TF-DR3-17-A



17" Vertical 2-Drawer & Paper Towel Holder Combo

TF-TDC-17-A



20" Trash Pullout Drawer

TF-TD1-20-A



20" Trash & Recycling 2-Bin Pullout Drawer

TF-TD2-20-A



17" Paper Towel Holder

TF-TH-17-A



20" Vented Liquid Propane Tank Or Trash Drawer

TF-DR1-20LP-A



26" Utensil Drawer

TF-DR1-26U-A



36" Warming Drawer

TF-WD-36

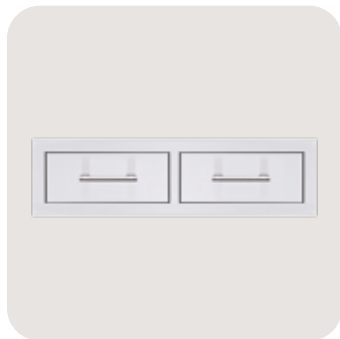

32" Double Horizontal Drawer

TF-DR2-32H-A



FEATURED: 20" TRASH PULLOUT DRAWER



FEATURED: 33" MASONRY DOUBLE ACCESS DOOR

MASONRY STORAGE

NEW PRODUCTS

Our line of Masonry Storage is perfect for islands with stone or brick finishes. The increased flange depth makes for a seamless fit and streamlined installation. These commercial grade stainless steel components can also be used to add an attractive contrast to any island with stucco or Ameristone finishes. 2024 hidden hinge & handle design.



20" Masonry Vented Liquid Propane Tank or Trash Drawer

TF-TD1-20M-A

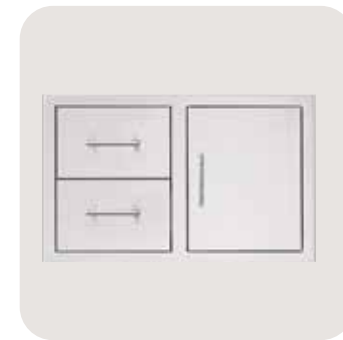

33" Masonry 2-Drawer & Access Door Combo

TF-DC2-33M-A

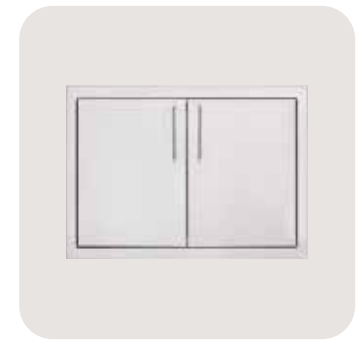

Masonry Double Access Door (33", 45")

TF-DD-33M-A / TF-DD-45M-A



17" Masonry Double Drawer

TF-DR2-17M-A



17" Masonry Vertical 2-Drawer & Paper Towel Holder Combo

TF-TDC-17M-A



20" Masonry Vertical Access Door

TF-DV-20M-A

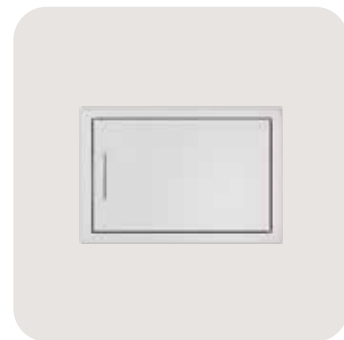

27" Masonry Horizontal Access Door

TF-DH-27M-A

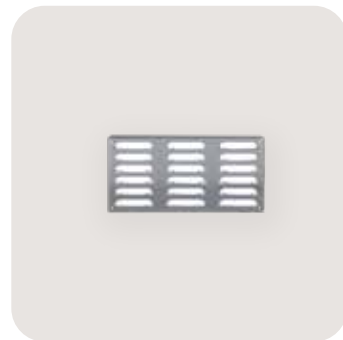

12" Masonry Island Vent Panel

TF-IV-12-A



PROUDLY MADE IN THE USA

DRY STORAGE

This line of dry storage pantries is a solution that offers heavy-duty weather-resistant seals to give you peace of mind year-round—that means moisture and critters are locked out for good. Made with high quality #304 stainless steel, these pantries feature heavy-duty flanges, soft closing drawers, new handle design, hidden hinge, and magnetic latches.

NEW PRODUCTS

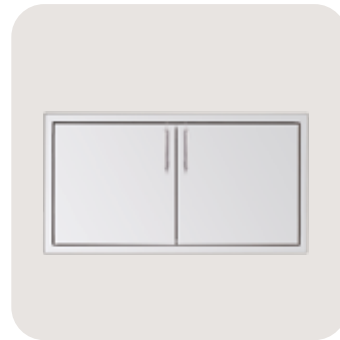

36" 2-Drawer Dry Storage Pantry & Enclosed Cabinet Combo

TF-DP-36DC-A

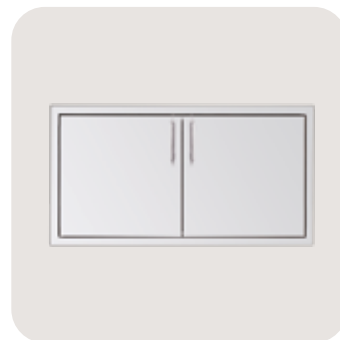

36" 2-Drawer Dry Storage Pantry & Access Door Combo

TF-DP-36AC-A



PROUDLY MADE
IN THE USA



FEATURED:
36" 2-DRAWER DRY STORAGE PANTRY & ACCESS COMBO
36" DOUBLE ACCESS DOOR
20" TRASH PULLOUT DRAWER

VENT HOODS

Protect your outdoor kitchen with our commercial-grade Vent Hoods. Many BBQ Islands and outdoor kitchens are made under a pergola or porch. A vent hood provides the protection you need to ensure a safe and reliable entertaining space for years to come. Each Vent Hood features durable double-lined #304 stainless steel construction for maximum strength and protection, stainless steel top/side mounting ducting, and a matching sleek design. The Vent Hood not only protects your outdoor kitchen but also protects the chassis of your built-in grill from corrosion, adding to the longevity of your grill. Use TrueFlame Vent Hoods to make your outdoor kitchen a safe and entertaining space for your family and friends to enjoy.

FEATURES

- 36" / 42" / 48" / 60"
- 36" - 1000 CFM
- 42" / 48" / 60" - 2000 CFM
- Dual Venting / Top or Rear
- Duct Covers Available
- #304 Stainless Steel Construction
- 1/2" Mounting Bracket Included
- Spacer Kits Available



Vent Hoods (36", 42", 48", 60")

TF-VH-36 / TF-VH-42-2
TF-VH-48-2 / TF-VH-60-2



12" Duct Cover (36", 42", 48", 60")

TF-VH-36-DC / TF-VH-42-2-DC
TF-VH-48-2-DC / TF-VH-60-2-DC



1/2" Mounting Bracket
(36", 42", 48", 60")

TF-VH-36-SPT / TF-VH-42-SPT
TF-VH-48-SPT / TF-VH-60-SPT



4" & 8" Spacer Brackets
(36", 42", 48", 60")

TF-VH-36-SP4 / TF-VH-42-SP4
TF-VH-48-SP4 / TF-VH-60-SP4
TF-VH-36-SP8 / TF-VH-42-SP8
TF-VH-48-SP8 / TF-VH-60-SP8



GAS TIMER & MOUNTING PLATE

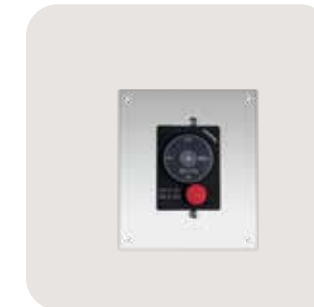

Gas Timer with
Emergency Shutoff /
Mounting Plate
*Mounting Plate Sold Separately

TF-ESTOP1-0H



Expandable Masonry Gas
Timer Kit

TF-ESTOP-CP-KIT



Gas Timer Locking
Cabinet

TF-ESTOP-LC-KIT /
TF-ESTOP-RM-KIT

WIND GUARDS



36" Stainless Steel Wind
Guard (Fits 25-32" Grills)

TFWG-36



48" Stainless Steel Wind
Guard (Fits 36-44" Grills)

TFWG-48



PROUDLY MADE
IN THE USA

GRILL & ISLAND ACCESSORIES

TrueFlame offers a variety of island accessories that help bring your outdoor kitchen to the next level. Deluxe covers, rotisserie kits, griddles, and more, our outdoor accessories complete your kitchen and ensure the highest quality culinary experience.



Grill Cover

TFGC-25 / TFGC-32 / TFGC-40



Cart Cover

CARTCOV-TF25 / CARTCOV-TF32
CARTCOV-TF40 / CARTCOV-TFGRID30

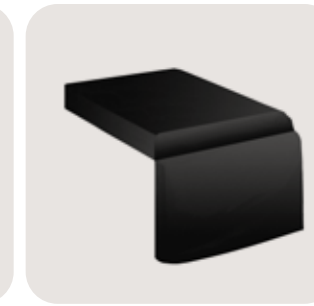

Side & Power Burner Cover

GRILLCOV-TFSB2 / GRILLCOV-TFPB

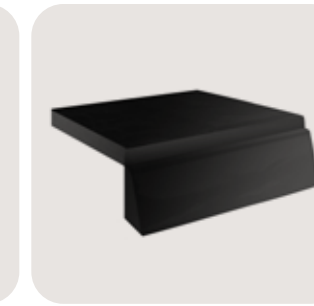

30" Gas Griddle Cover

TFGC-GRID30



Rotisserie Bag

TF-GRILLCOV-ROT32 / TF-GRILLCOV-ROT44

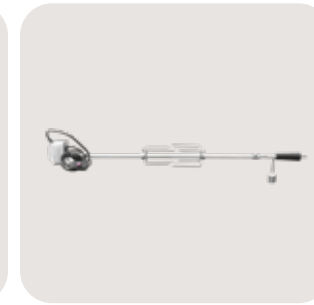

25", 32" & 40" Rotisserie Kit

TFRK-25 / TFRK-32 / TFRK-40



Grill Liner

GL-TF25 / GL-TF32 / GL-TF40 / GL-TFGRID30



Side & Power Burner Liner Kit

GL-TFSB2 / GL-TFPB



Refrigerator Trim
15"/22"/24" Series

TF-RTK-15 / TF-RTK-22
TF-RTK-24SM / TF-RTK-24LG
TF-RTK-24W / TF-RTK-IM

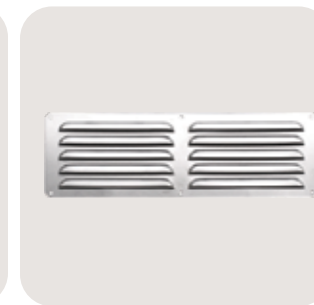

14" Island Vent Panel

TF-IV-14



1.75"/2" Umbrella Countertop Mounting Stanchion

TF-US-1 / TF-US-1L

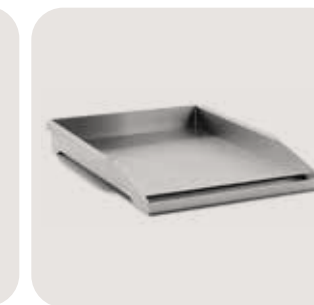

Griddle Plate

TF-GP-14

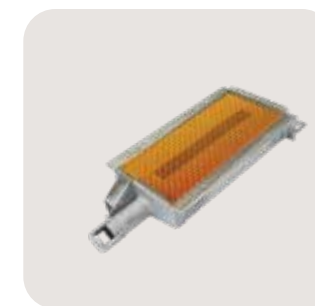

TrueFlame Drop-In Infrared Sear Burner

TF-IRB

*REFRIGERATION DOOR LINERS AVAILABLE

PRODUCT DIMENSIONS

To view our recommended cutout dimensions, scan the QR Code or visit the link: www.trueflame.com/outdoor-kitchens/cutouts

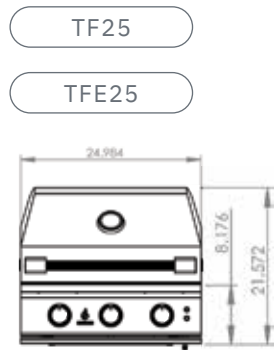

Front View

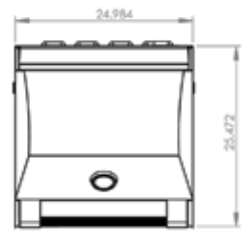

Top View

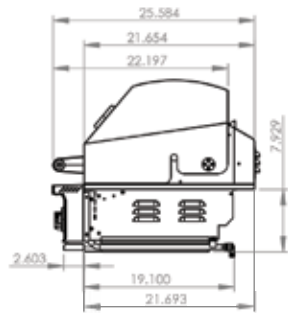

Side View

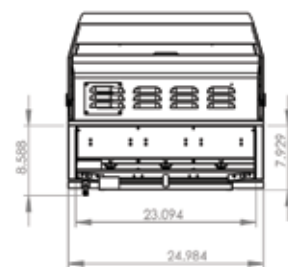

Back View

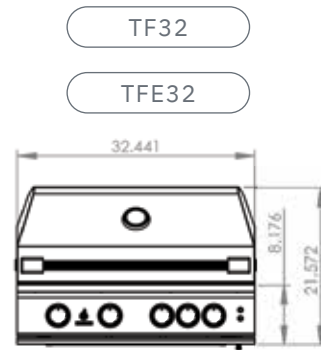

Front View



Top View

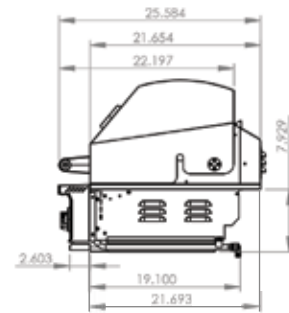

Side View

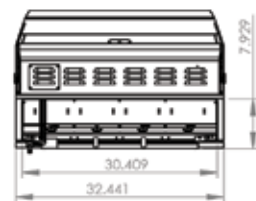

Back View

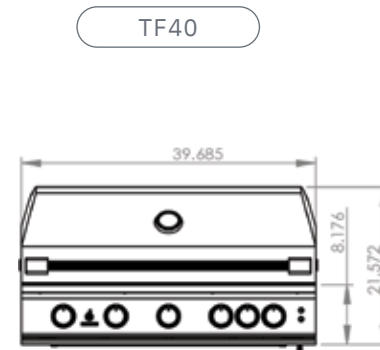

Front View

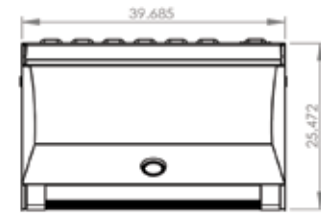

Top View

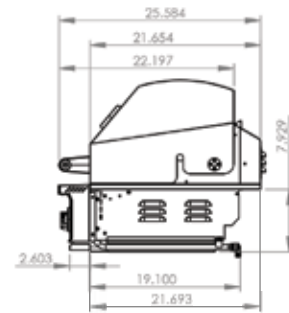

Side View

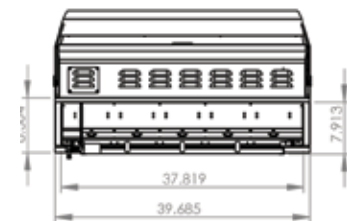

Back View

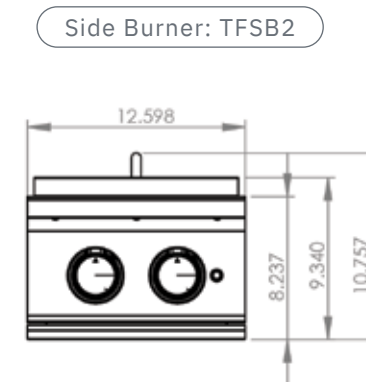

Front View

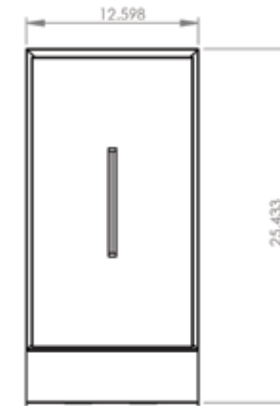

Top View

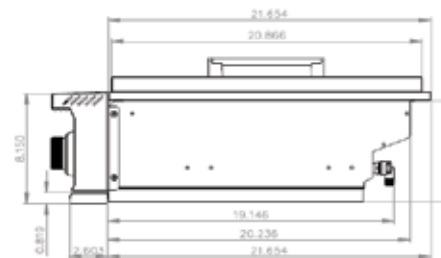

Side View

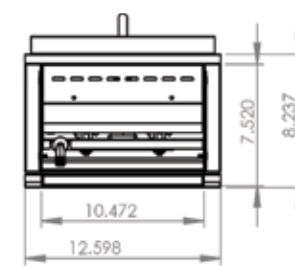

Back View

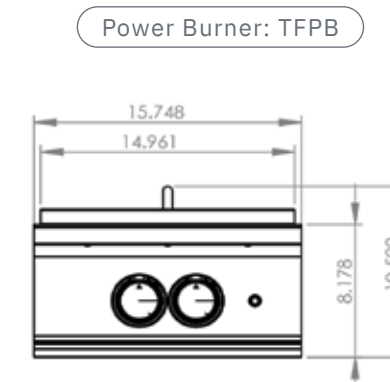

Front View

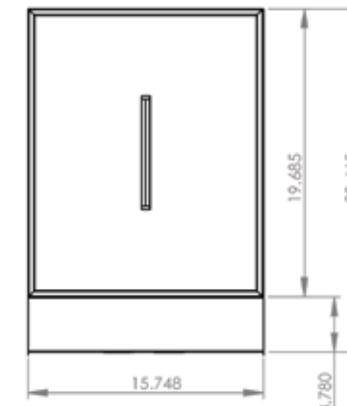

Top View

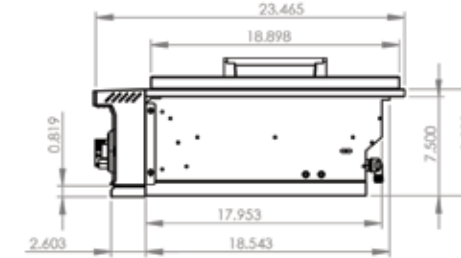

Side View

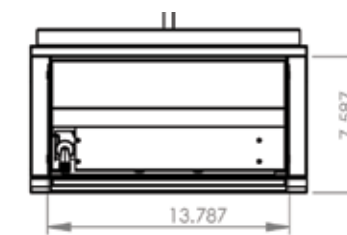

Back View

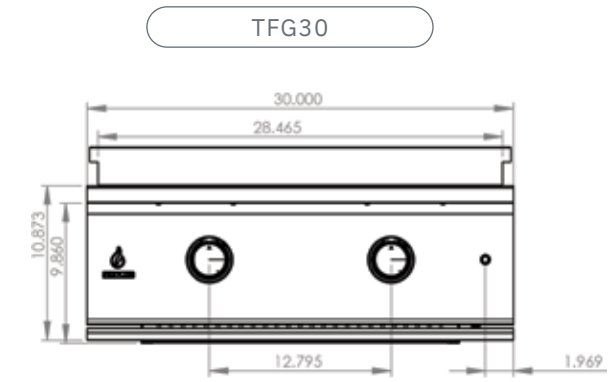

Front View

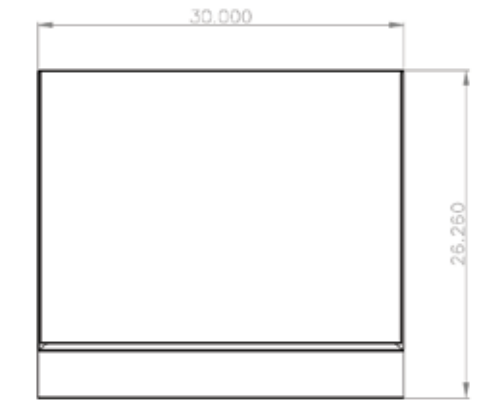

Top View

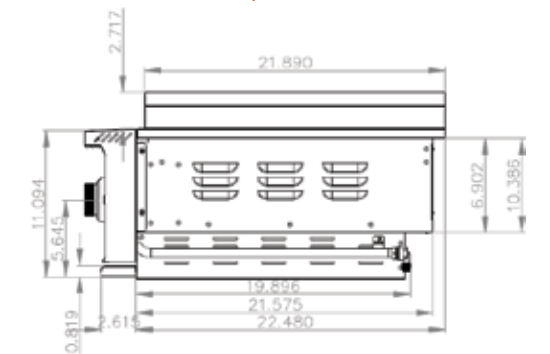

Side View

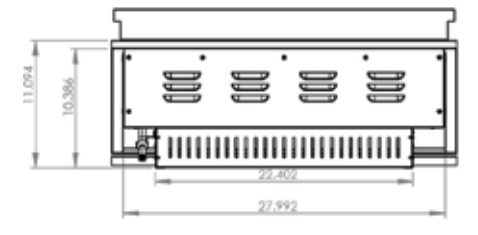

Back View



GOLD STANDARD WARRANTY

Your investment in TrueFlame products is backed by the strongest warranty in the industry. In addition to precision engineering and outstanding performance, TrueFlame products include our GOLD STANDARD LIFETIME WARRANTY with all replacement parts 100% non-prorated. Effective with purchases as of 3/1/23.

TrueFlame Warranty is valid for original purchaser at original site of delivery with proof of purchase and photo documentation only. Registration form must be submitted online within 30 days of the purchase date to validate the warranty. Warranty is void upon transfer of ownership. Warranty does not apply to products installed in any commercial, rental, or nonresidential application that have not maintained proper upkeep. Warranty covers replacement parts only. Manufacturer is not responsible for labor or labor-related costs. Warranty does not cover discoloration, surface rust, corrosion, or oxidation, which may occur due to harsh environments, chemicals, or overheating. Warranty will not apply for damage resulting from improper installations, abuse, extreme environments, grease fires, or misuse. Proof of regular and proper maintenance is required. Coastal, humid, and/or salt environments are subject to manufacturer review. All out-of-box claims must be made within 30 days of purchase and must be made prior to installation. Any product installed damaged will be considered damaged during installation and not covered under warranty. Warranty and registration forms are available at www.amddirect.com/register. Please be advised - all display models are sold "as is" and the warranty covers the following items only: main burners (Gold Standard Lifetime Warranty), grates (Gold Standard Lifetime Warranty), burner covers (Gold Standard Lifetime Warranty). All warranties are subject to the review and approval of the manufacturer.

14520 DELTA LANE SUITE 105,
HUNTINGTON BEACH, CA 92647

800.966.8126

AMDDIRECT.COM

GAS APPLIANCES (GRILLS, SIDE/POWER BURNERS, GAS GRIDDLE)

- Gold Standard Lifetime Warranty on Construction and Manufacturer Defects
- Gold Standard Lifetime Warranty on Stainless Steel Construction
- Gold Standard Lifetime Warranty on Cooking Grates, Burners, Burner Covers, Valves, Flame Tamers, Heatzone Separators & Temperature Gauges
- 3 Year Warranty on All Other Parts, Components, & Electrical, including: LED Bulbs, Wire Harness, Switches; Power Source Wire; Transformer; Interior Halogen Light Wire & Bulb

VENT HOODS, REFRIGERATION, COLD STORAGE & SINKS

VENT HOODS

- 5 Year Warranty on all Stainless Steel Construction
- 3 Year Warranty on Blowers, LED Lighting, Wiring Harness and Switches

15" & 24" REFRIGERATION MODELS

- 3 Year Warranty on All Construction Including Compressors
- 1 Year Warranty on Transformer, LED Bulbs, LED Harness, Power Source Wire, LED Switches, Interior Halogen Light Wire/Bulbs

21" & 22" REFRIGERATION MODELS

- 1 Year Warranty on all Construction & Electrical Components Including Compressor, Transformer, LED Bulbs, LED Harness, Power Source Wire, LED Switches, Interior Halogen Light Wire/Bulbs

COLD STORAGE & SINKS

- Gold Standard Lifetime Warranty on Ice Chest
- Gold Standard Lifetime Warranty on Drains & Faucets

DRAWERS, DOORS, GRILL LINERS, & CARTS

- Gold Standard Lifetime Warranty on Construction, Workmanship and Materials for All Stainless Steel Parts, Including Doors, Drawers, Grill Liners, & Carts
- 3 Year Warranty on Electrical (Warming Drawers)

COVERS

- Gold Standard Lifetime Warranty on Covers, Including Grills, Carts, Side/Power Burners, Gas Griddle

COMMERCIAL APPLICATIONS

GAS GRILLS

- Gold Standard Lifetime Warranty on Workmanship, Construction, & Manufacturer Defects for All Commercial and/or Hospitality Applications
- Warranty is Void Upon Misuse, including Lack of Regular Cleaning, Vandalism, or Theft
- Warranty is Valid only if Regular Maintenance is Exercised. Due to the Nature of Commercial Applications (Multiple Users, Lack of Control of Use, etc.) Regular Maintenance is Mandatory



